



# KIP 720

CIS SCANNING SYSTEM



# KIP 720 SCANNING SYSTEM

## KIP 720 Image Scanner

The KIP 720 color & monochrome scanner delivers large-format scanning and copying functionality with world-class scanning speeds and unbeatable image accuracy.

The KIP 720 large format scanner is a 24-bit, 36" wide full-color image capture system perfect for processing photographs, complex maps, and AEC/ CAD drawings.

## Benefits of CIS Scanning

### Technology Sharp Image Scanning

The KIP 720 CIS (Contact Image Sensor) technology scanning method enables high resolution, high speed image capture with energy saving operation in a light, compact and portable design.

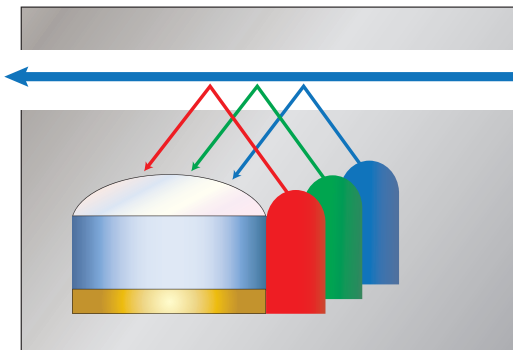

*CIS technology features a series of Red, Green and Blue lights that illuminate in turn to capture image data related to each color.*

## Key Features

- **36" Wide**
- **Face-up document scanning**
- **True 600x600 dpi optical resolution**
- **CIS scanning technology provides high definition scans**
- **Real Time Thresholding Technology (RTT)**
- **No folded optics—No warm-up time**
- **0.1% scanning accuracy**
- **High resolution, high speed user-friendly operation with smart energy usage for maximum environmental conscientiousness**
- **High Definition scanning that advances graphical image capture possibilities**

## Advanced RTT Technology



KIP's Real Time Thresholding technology automatically optimizes background levels for each original, creating smooth reproductions of halftone gradients. KIP RTT technology automatically adjusts the threshold levels on a standard "D" size document over half a million times per scan!





## Full Color Workflow Integration

The KIP 720 standalone scanner system provides accurate, professional results based on true 600 dpi optical resolution and 24-bit color imaging technology. Scan full color technical documents, maps, posters and photos into a variety of file formats for E-mail, archive and print purposes.

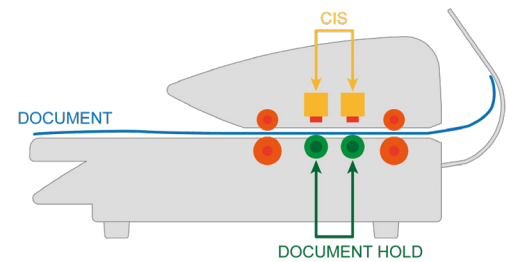

*A specialized support system under the document enhances feed reliability.*

### Productive:

- High-speed, high-resolution CIS document image capture
- 4.5 seconds monochrome 'D' Size
- 14 seconds color 'D' Size

### Quality:

- High-resolution, 600dpi scanning
- 24-Bit color depth

### Responsive:

- Ready in less than 10 seconds

### Earth Conscious:

- Compact & Lightweight
- Compatible with Energy Star program & RoHS
- Scans recycled medias



## KIP 720 / 2300 Stand Alone Scan Station

# KIP ImagePro – Scan & Copy

KIP ImagePro – Scan & Copy software is the professional's choice for wide format production Scan & Copy providing a complete set of features for high resolution colour and B&W copying & scan-to-file applications. For exclusive use with the KIP 720 and KIP 2300 scanners.

KIP ImagePro tools are designed to enhance colour management capabilities. KIP ImagePro offers extensive features for increased productivity including image quality adjustments, high definition viewer with advanced Area of Interest functions, auto document width detection along with Auto Start for stream feeding originals, scan to local drives, LAN locations, USB and cloud storage.

Simplify document quality when scanning or copying difficult originals by selecting b&w point settings on-the-fly adjustments to quickly snap text to solid black or to clean up background. Deskew documents automatically. Sophisticated project details can be highlighted with Advanced Area of Interest selections. KIP Smart Stack simplifies the accurate collation of mixed sets of colour and black and whites prints. The professional colour editor included with KIP ImagePro offers a high definition colour editor with real time colour correction viewing. Create impressive vibrant colour impact for posters, banners, point of purchase, business communications, safety, and technical images. Streamline colour correction with colour exchange selections from a choice of multiple colour spaces for optimal results.

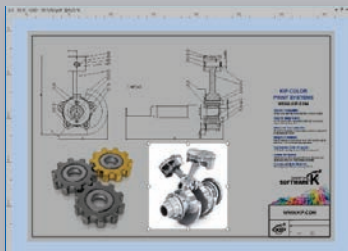

Area of Interest (AOI)

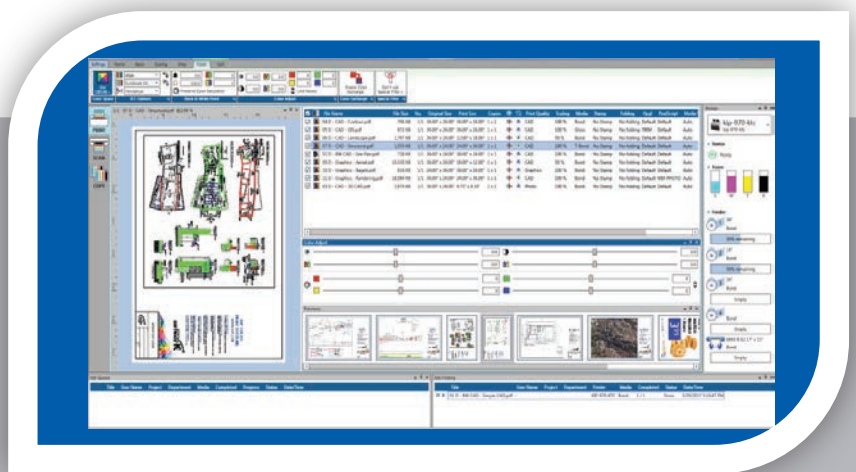

Matrix Scan & Copy with HD Viewer, "Pop out" Panels & Device Status

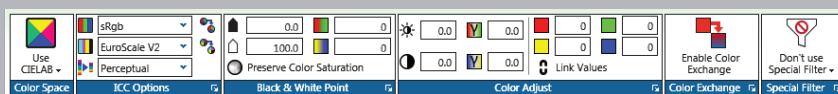

Professional Colour Management

## KIP ImagePro Key Features



Auto Start for Stream Feed Productivity | Auto Width Detection | Auto Deskew | Auto Increment of File Name | Advanced Area of Interest Selection | Professional Color Editor & Correction Features | KIP Smart Stacking | High Definition Viewing | Customizable Interface for Personalized View

### KIP ImagePro – Scan & Copy Feature Descriptions



#### File Renaming Mode

Rapidly rename hundreds of files with KIP's file renaming tool. Batch scan using production file naming conventions and rename the files post scanning. Use KIP's HD Viewer to zoom in and lock onto the title block area. Enter a new name and press enter to auto zoom to the same location on the next file.



#### Image Navigator

Within the KIP High Definition viewer, quickly navigate long length images or jump to any position with the Image Navigator. The repositionable thumbnail displays the current location on the zoomed in image. Set the location of the thumbnail view in any of the four corners. Select any new location or drag the Navigator box to change locations.



#### Stream Feeding Productivity

Auto Start for continuous original document feeding for maximum productivity | Auto De-skew | Auto Width Detection | Auto File Name Increment | Auto Length Detection | Live Preview



#### Advanced Area of Interest

Select Size | Position | Save only the "area of interest" to enhance communication of sophisticated or important details



#### Professional Color Editor & Correction Features

High definition color editor with real time color correction viewing to create impressive vibrant color impact for posters, banners, point of purchase, business communications, safety, and technical images. Streamlines color correction with color exchange selections from a choice of multiple color spaces for optimal results.



#### High Definition Viewing

High resolution image pre-flight viewer to include review of color adjustments and preset creations | Color or B&W | AOI Selection - Scale, Position, Print | Page ruler | View Scale to Pixels or In-Screen



#### Customizable Interface for Personalized View

Access your preferred productivity features with ease using "Pop Out" tools and panels



#### Scan Mode

B&W, Grayscale & Color Scan to File | Scan to Local Drive, USB, LAN or Cloud locations | Wide Variety of File Formats | Scan to Multi-Page PDF and TIF | Set Image Compression | Utilize Templates | Embed Stamps | Control Margins | Mirror and Rotation



#### Copy Mode

Copy to KIP System K B&W and Color Systems | B&W, Grayscale and Color Adjustments | Save Unlimited Presets and

# KIP 720 SPACE REQUIREMENTS

## KIP 720 Scanning System Space Requirements

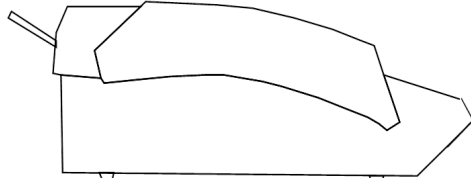

KIP 720 Side View



KIP 720 Front View

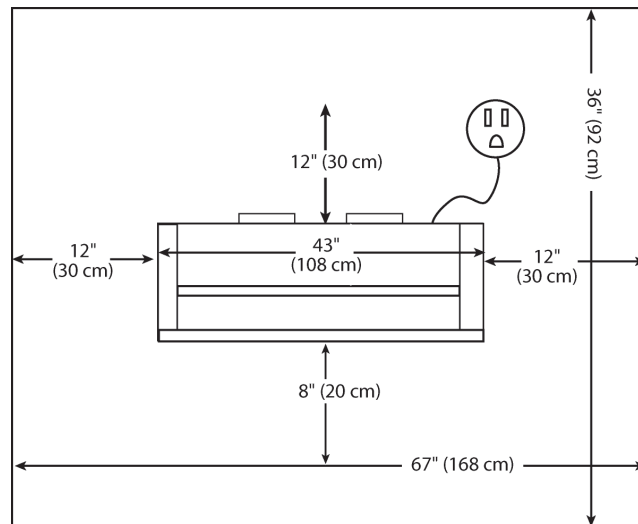

KIP 720 Top View

# KIP 720 SPECIFICATIONS



General Specifications	
Scanner Type	C.I.S. with KIP RTT Technology
Scan Resolution	600 x 600 dpi optical resolution
Scan Speed	Up to 8 ips / 203 mm per second (B&W) Up to 2.6 ips / 66 mm per second (Color)
Scan Format	TIFF, Multipage TIFF, PDF, PDF-A, Multipage PDF, DWF, Multipage DWF, JPEG, CALS
Scan Destination	Local USB (Removable Media), Unlimited IPS Mailboxes (Local), Unlimited FTP, Unlimited SMB
Original Size Width	11" - 36" / 279 - 914 mm
Original Thickness	Up to 1.6 mm thick
Interface	USB 2.0
Dimensions	43" x 16" x 6.7" / 1,092 mm x 406 mm x 170 mm
Weight	53lbs / 25 Kg
Electrical	100-240 V AC 50/60 Hz
Power Consumption	<50 W
Minimum PC Requirements (NOT INCLUDED WITH SCANNER)	Quad Core Processor ( such as an Intel i5 or higher ) Windows 10 8GB RAM 1 TB Hard Drive 1 Gig RJ45 LAN Port One USB 2.0 Port (scanner connection) 27" Wide Screen Flat panel monitor USB keyboard and mouse



**For more information:**



**topconsolutions.com**  
**(855) 289-1772**